



\* Stand is optional



### Versatile Connection

Multiple inputs enable flexible connection by applications: VGA & DVI input for general connection, HDMI input/output featuring PIP /PBP function for multi-modality, and optional 3G-SDI module for advanced endoscopy system.



### Accurate Image Viewing

The compliance with DICOM/ GAMMA ensures optimized color and gray scale reproduction for best image accuracy.



### Exceptional Clarity

The 700-nits high brightness enhances clarity and details for both color and grayscale images.



### Multimodality Imaging

The picture-in-picture (PIP) and picture-by-picture settings allow multimodality display capability for various image combinations.

## Selection Guide

	With VGA & DVI input for general connection	With analog video input for traditional system	With 3G-SDI input for advanced system
Without HDMI Input/output	MMS-27C	MMS-27CA	MMS-27CS MMS-27CAS
With HDMI Input/output for PIP/PBP Display	MMS-27CH	MMS-27CAH	MMS-27CHS MMS-27CAHS



# Dimensions (unit: mm)

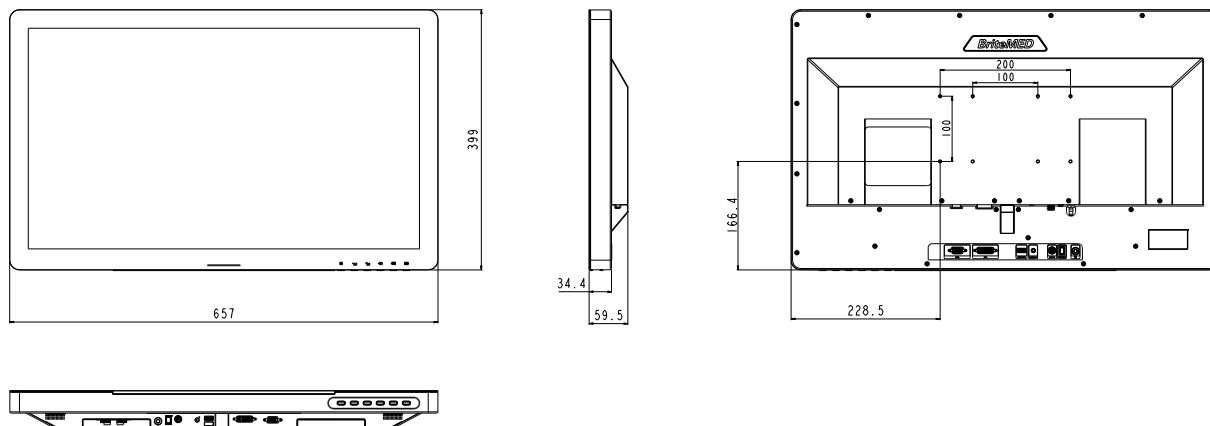

# I/O Interface

## MMS-27C

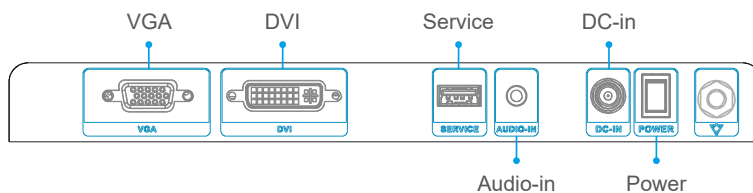

## MMS-27CA

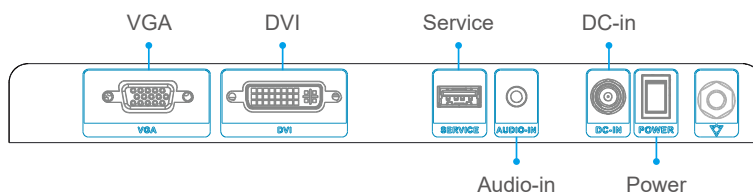
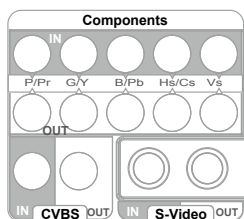

## MMS-27CH

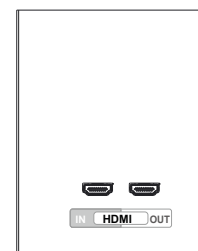
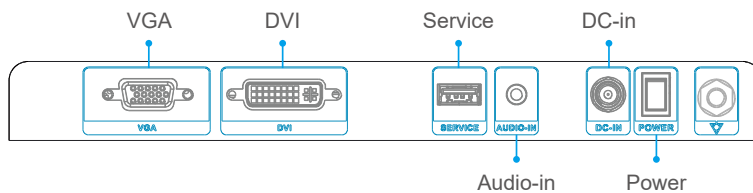

## MMS-27CAH

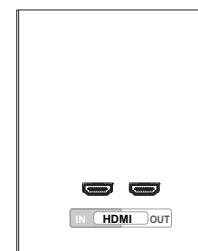
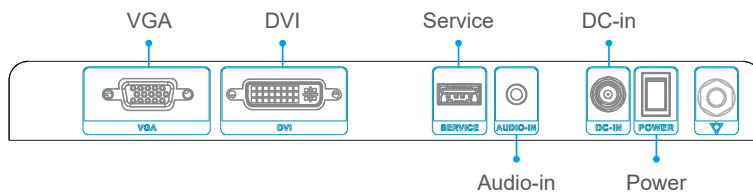
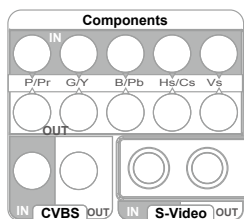

## MMS-27CS

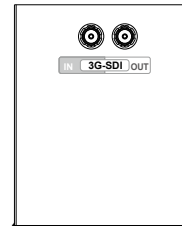
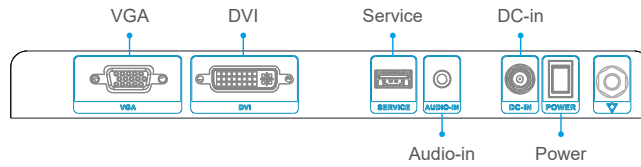

## MMS-27CAS

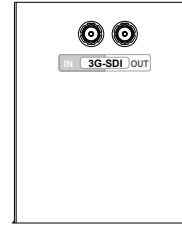
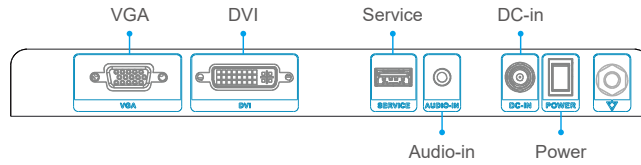

## MMS-27CHS

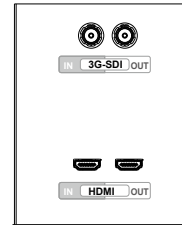
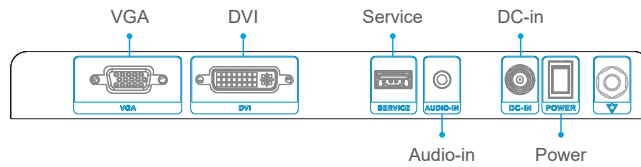

## MMS-27CAHS

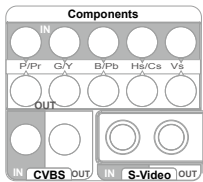
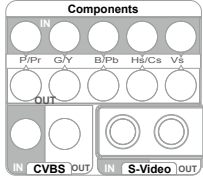
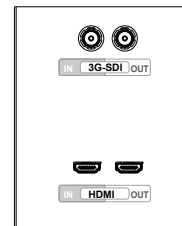
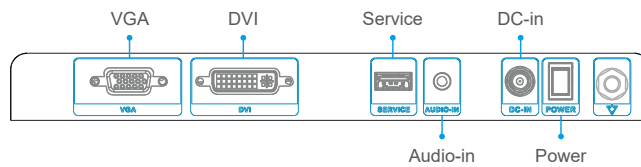

## Ordering Information

Part No.	Description
MMS-27C-R10	27" 1920x1080 color monitor, VGA/DVI-D input, 100-240V AC to 12V DC power adaptor
MMS-27CA-R10	27" 1920x1080 color monitor, VGA/DVI-D/Component/CVBS/S-Video input, 100-240V AC to 12V DC power adaptor
MMS-27CH-R10	27" 1920x1080 color monitor, VGA/DVI-D/HDMI input, 100-240V AC to 12V DC power adaptor
MMS-27CAH-R10	27" 1920x1080 color monitor, VGA/DVI-D/Component/CVBS/S-Video/HDMI input, 100-240V AC to 12V DC power adaptor
MMS-27CS-R10	27" 1920x1080 color monitor, VGA/DVI-D/3G SDI input, 100~240 VAC to 12V DC power adaptor
MMS-27CAS-R10	27" 1920x1080 color monitor, VGA/DVI-D/Component/CVBS/S-Video/3G SDI input, 100~240 VAC to 12V DC power adaptor
MMS-27CHS-R10	27" 1920x1080 color monitor, VGA/DVI-D/HDMI/3G SDI input, 100~240 VAC to 12V DC power adaptor
MMS-27CAHS-R10	27" 1920x1080 color monitor, VGA/DVI-D/Component/CVBS/S-Video/HDMI/3G SDI input, 100~240 VAC to 12V DC power adaptor

## Factory Options

Part No.	Description
STAND-DWH-R10	VESA 75/100 stand, supports up to 15 kg, white
WK-E35M-R10	VESA 100/200/200x100 wall mount kit, supports up to 35 kg, silver

Specifications may change without further notice.

Biomedical Equipment Corp.  
 10421 NW 28th St. STE D102, Doral, FL USA  
 Tel: +1-305-463-9447  
 Email: info@4biomed.com  
 www.4biomed.com

**Celebrate Humanity With Technology**